

DEVICE SPECIFICATIONS

NI PXI-2545

2.7 GHz Terminated 4 × 1 Multiplexer (SP4T)

This document lists specifications for the NI PXI-2545 (PXI-2545) multiplexer module. All specifications are subject to change without notice. Visit ni.com/manuals for the most current specifications.

Contents

About These Specifications.....	1
Input Characteristics.....	2
RF Performance Characteristics.....	2
Termination Derating.....	5
Dynamic Characteristics.....	6
Trigger Characteristics.....	6
Physical Characteristics.....	6
Environment.....	7
Shock and Vibration.....	7
Compliance and Certifications.....	8
Diagrams.....	9
Accessories.....	10

About These Specifications

Specifications characterize the warranted performance of the instrument under the stated operating conditions. Data in this document are *Specifications* unless otherwise noted.

Typical Specifications are specifications met by the majority of the instrument under the stated operating conditions and are tested at 23 °C ambient temperature. Typical specifications are not warranted.

All voltages are specified in DC, AC_{pk}, or a combination unless otherwise specified.

Topology

Terminated 4 × 1 multiplexer

Refer to the *NI Switches Help* at ni.com/manuals for detailed topology information.



Caution The protection provided by the PXI-2545 can be impaired if it is used in a manner not described in this document.

Input Characteristics

Maximum switching voltage	30 V
Maximum switching current (per channel)	0.5 A
Maximum carry current (per channel)	0.5 A
Maximum RF power	
Channel to common	10 W
Termination (≤ 25 °C ambient)	1.5 W
Minimum switch load	0 dBm



Caution The switching power is limited by the maximum switching current and the maximum voltage. Channel-to-common switching power must not exceed 10 W.



Caution Terminations cannot withstand the full rated power of the PXI-2545.



Note NI recommends against switching active RF signals. As a relay actuates, the channel is momentarily unterminated. Some RF sources can be damaged by reflections if their outputs are not properly terminated. Refer to your RF source documentation for more information.



Note Switching active RF signals below 0 dBm may degrade signal integrity and decrease relay life. For more information about switching active RF signals, visit ni.com/info and enter Info Code `RFSwitching`.

DC path resistance

Initial	$< 0.25 \Omega$, typical
End-of-life	$\geq 1.0 \Omega$, typical

Path resistance is a combination of relay contact resistance and trace resistance. Contact resistance typically remains low for the life of a relay. At the end of relay life, the contact resistance rises rapidly above 1.0Ω .

Related Information

[Termination Derating](#) on page 5

RF Performance Characteristics

Characteristic impedance (Z_0)	50 Ω , nominal
Insertion loss	
≤ 1 GHz	< 1.0 dB (< 0.85 dB, typical)
≤ 2.7 GHz	< 2.0 dB (< 1.7 dB, typical)

Voltage standing wave ratio (VSWR), channel to common

≤ 1 GHz	<1.3 (<1.25, typical)
≤ 2.7 GHz	<1.6 (<1.45, typical)

Isolation

≤ 1 GHz	>60 dB, typical
≤ 2.7 GHz	>45 dB, typical

Channel-to-channel skew <15 ps, typical

Propagation delay 1.3 ns, typical

Rise time (10% to 90%) 93 ps, typical

Refer to the following figures for typical insertion loss, typical channel to common VSWR, typical termination VSWR, and typical isolation.

Figure 1. Insertion Loss, Typical

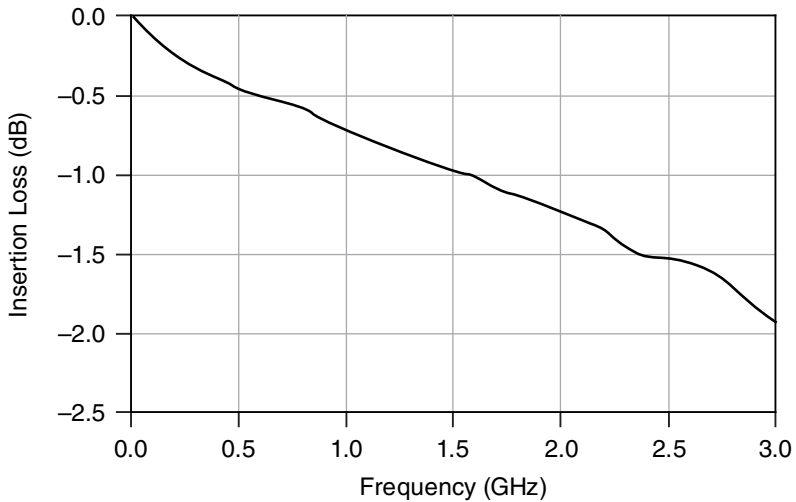

Figure 2. Channel to Common VSWR, Typical

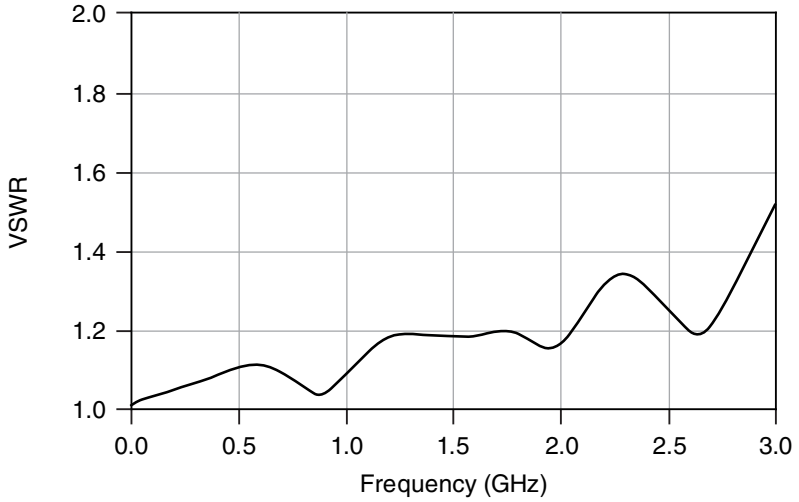

Figure 3. Termination VSWR, Typical

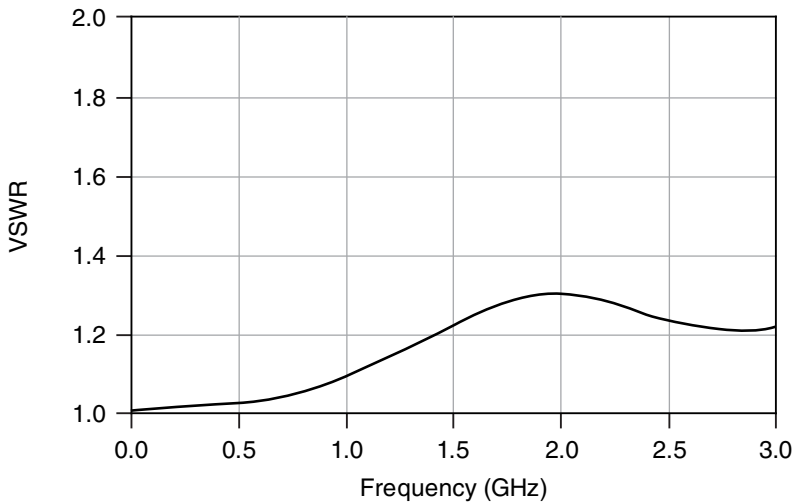
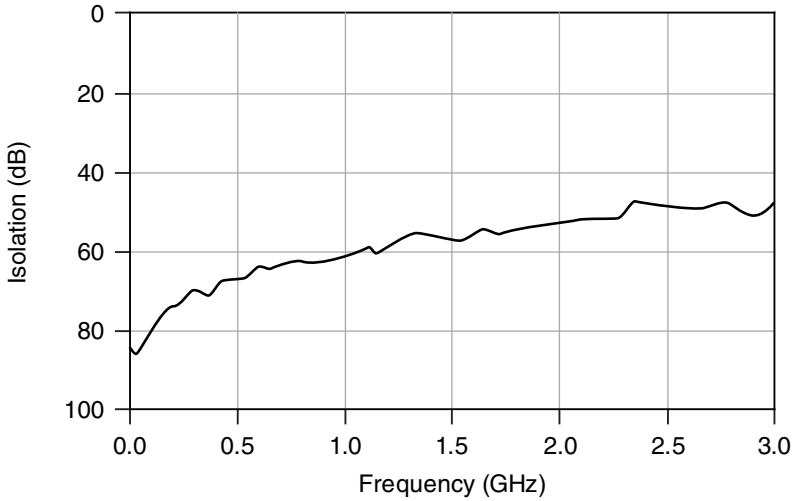

Figure 4. Isolation, Typical



Termination Derating



Caution When operating the PXI-2545 at ambient temperatures $>25^{\circ}\text{C}$, the derating in the following figure limits the maximum constant power each termination can dissipate.

Figure 5. Termination Derating

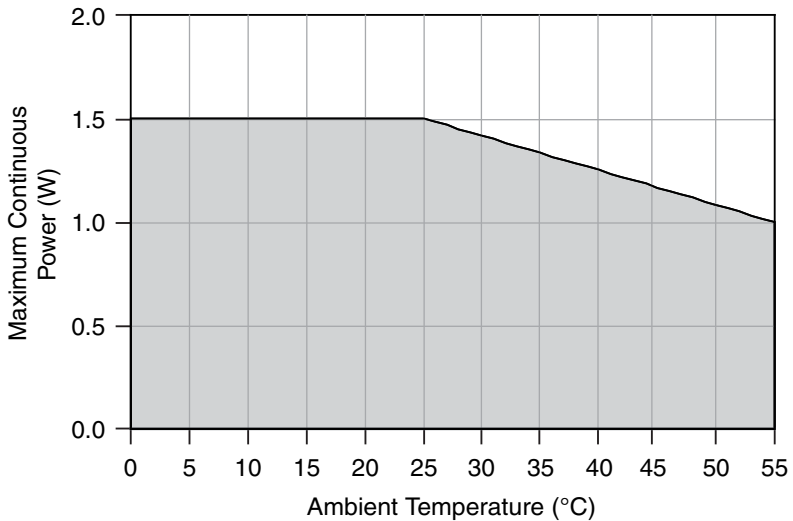



Caution Failure to operate below listed power limits can result in permanent damage to the device.

Dynamic Characteristics

Maximum relay operate time	10.4 ms
----------------------------	---------



Note Certain applications may require additional time for proper settling. Refer to the *NI Switches Help* at ni.com/manuals for more information about including additional settling time.

Expected relay life	
Mechanical	1×10^6 cycles
Electrical (30 V, 10 mA, DC resistive)	3×10^5 cycles

Trigger Characteristics

Input trigger	
Sources	PXI trigger lines <0...7>
Minimum pulse width	150 ns



Note The PXI-2545 can recognize trigger pulse widths less than 150 ns if you disable digital filtering. Refer to the *NI Switches Help* at ni.com/manuals for information about disabling digital filtering.

Output trigger	
Destinations	PXI trigger lines <0...7>
Pulse width	Programmable (1 μ s to 62 μ s)

Physical Characteristics

Relay type	Electromechanical, latching
I/O connectors	5 SMA jacks, gold plated
PXI power requirement	3.7 W at 5 V 0.3 W at 3.3 V
Dimensions (L \times W \times H)	3U, one slot, PXI/cPCI module 21.6 cm \times 2.0 cm \times 13.0 cm (8.5 in. \times 0.8 in. \times 5.1 in.)
Weight	255 g (9 oz)

Environment

Maximum altitude	2,000 m (at 25 °C ambient temperature)
Pollution Degree	2

Indoor use only.

Operating Environment

Ambient temperature range	0 °C to 55 °C (Tested in accordance with IEC 60068-2-1 and IEC 60068-2-2.)
Relative humidity range	10% to 90%, noncondensing (Tested in accordance with IEC 60068-2-56.)

Storage Environment

Ambient temperature range	-20 °C to 70 °C (Tested in accordance with IEC 60068-2-1 and IEC 60068-2-2.)
Relative humidity range	5% to 95%, noncondensing (Tested in accordance with IEC 60068-2-56.)

Shock and Vibration

Operational shock	30 g peak, half-sine, 11 ms pulse (Tested in accordance with IEC 60068-2-27. Test profile developed in accordance with MIL-PRF-28800F.)
Random vibration	
Operating	5 Hz to 500 Hz, 0.31 g _{rms} (Tested in accordance with IEC 60068-2-64.)
Nonoperating	5 Hz to 500 Hz, 2.46 g _{rms} (Tested in accordance with IEC 60068-2-64. Test profile exceeds the requirements of MIL-PRF-28800F, Class 3.)

Compliance and Certifications

Safety

This product is designed to meet the requirements of the following electrical equipment safety standards for measurement, control, and laboratory use:

- IEC 61010-1, EN 61010-1
- UL 61010-1, CSA 61010-1



Note For UL and other safety certifications, refer to the product label or the [Online Product Certification](#) section.

Electromagnetic Compatibility

This product meets the requirements of the following EMC standards for electrical equipment for measurement, control, and laboratory use:

- EN 61326-1 (IEC 61326-1): Class A emissions; Basic immunity
- EN 55011 (CISPR 11): Group 1, Class A emissions
- AS/NZS CISPR 11: Group 1, Class A emissions
- FCC 47 CFR Part 15B: Class A emissions
- ICES-001: Class A emissions



Note In the United States (per FCC 47 CFR), Class A equipment is intended for use in commercial, light-industrial, and heavy-industrial locations. In Europe, Canada, Australia, and New Zealand (per CISPR 11), Class A equipment is intended for use only in heavy-industrial locations.



Note Group 1 equipment (per CISPR 11) is any industrial, scientific, or medical equipment that does not intentionally generate radio frequency energy for the treatment of material or inspection/analysis purposes.



Note For EMC declarations and certifications, refer to the [Online Product Certification](#) section.

CE Compliance

This product meets the essential requirements of applicable European Directives, as follows:

- 2014/35/EU; Low-Voltage Directive (safety)
- 2014/30/EU; Electromagnetic Compatibility Directive (EMC)

Online Product Certification

Refer to the product Declaration of Conformity (DoC) for additional regulatory compliance information. To obtain product certifications and the DoC for this product, visit ni.com/certification, search by model number or product line, and click the appropriate link in the Certification column.

Environmental Management

NI is committed to designing and manufacturing products in an environmentally responsible manner. NI recognizes that eliminating certain hazardous substances from our products is beneficial to the environment and to NI customers.

For additional environmental information, refer to the *Minimize Our Environmental Impact* web page at ni.com/environment. This page contains the environmental regulations and directives with which NI complies, as well as other environmental information not included in this document.

Waste Electrical and Electronic Equipment (WEEE)



EU Customers At the end of the product life cycle, all NI products must be disposed of according to local laws and regulations. For more information about how to recycle NI products in your region, visit ni.com/environment/weee.

电子信息产品污染控制管理办法（中国 RoHS）



中国客户 National Instruments 符合中国电子信息产品中限制使用某些有害物质指令 (RoHS)。关于 National Instruments 中国 RoHS 合规性信息，请登录 ni.com/environment/rohs_china。(For information about China RoHS compliance, go to ni.com/environment/rohs_china.)

Diagrams

The following figure shows the PXI-2545 power-on state.

Figure 6. PXI-2545 Power-On State

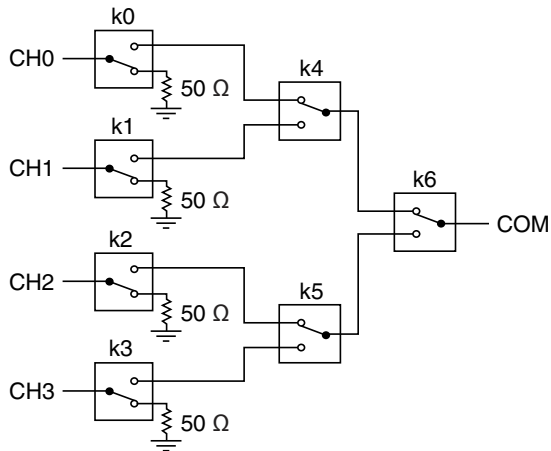

The following figure shows the PXI-2545 front panel connectors.

Figure 7. PXI-2545 Front Panel Connectors

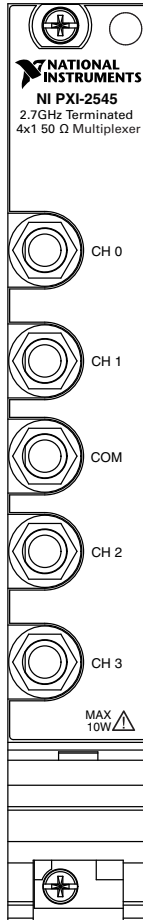

Note For topology-specific connection information, refer to your device in the *NI Switches Help* at ni.com/manuals and associated cable or terminal block installation instructions.

Accessories

Visit ni.com for more information about the following accessories.

Table 1. NI Accessories for the PXI-2545

Accessory	Length	Part Number
SMA 100, SMA male to SMA male flexible cable	0.15 m	763443-01
	0.45 m	763444-01
MCX plug to SMA plug	0.3 m	188377-0R3
	1.0 m	188377-01
Torque wrench for SMA connectors	-	187106-01
SMA plug (female) to SMB jack (male) adapter	-	779674-01



Caution You must install mating connectors according to local safety codes and standards and according to the specifications provided by the manufacturer. You are responsible for verifying the safety compliance of third-party connectors and their usage according to the relevant standard(s), including UL and CSA in North America and IEC and VDE in Europe.

Refer to the *NI Trademarks and Logo Guidelines* at ni.com/trademarks for information on NI trademarks. Other product and company names mentioned herein are trademarks or trade names of their respective companies. For patents covering NI products/technology, refer to the appropriate location: **Help»Patents** in your software, the `patents.txt` file on your media, or the *National Instruments Patent Notice* at ni.com/patents. You can find information about end-user license agreements (EULAs) and third-party legal notices in the readme file for your NI product. Refer to the *Export Compliance Information* at ni.com/legal/export-compliance for the NI global trade compliance policy and how to obtain relevant HTS codes, ECCNs, and other import/export data. NI MAKES NO EXPRESS OR IMPLIED WARRANTIES AS TO THE ACCURACY OF THE INFORMATION CONTAINED HEREIN AND SHALL NOT BE LIABLE FOR ANY ERRORS. U.S. Government Customers: The data contained in this manual was developed at private expense and is subject to the applicable limited rights and restricted data rights as set forth in FAR 52.227-14, DFAR 252.227-7014, and DFAR 252.227-7015.

© 2007—2016 National Instruments. All rights reserved.

374511G-01 Jul16